

INSTALLATION &
OPERATION
MANUAL

SAGA1-L Series
- SAGA1-L10
- SAGA1-L12



SAGA 1-L10/L12 User's Manual

Table Of Contents

Chapter 1	Warranty
	1-1 Warranty
	1-2 Warranty Period
	1-3 Excluded Items
	1-4 Remarks
Chapter 2	Operating Precautions
	2-1 Attention
	2-2 Precautions
	2-3 Emergency Procedures
Chapter 3	Standard Accessories
Chapter 4	Operation
	4-1 Transmitter Configuration
	4-2 General Operation
	4-3 Special Functions Operation
	4-4 The Use of Copier
	4-5 Change of Frequency
	4-6 ID-Code Remote Setting
	4-7 Receiver Voltage Selection
	4-8 Transmitter Battery Adoption

Appendix:

- I. Function Setting (Defined by Customer)
- II. Correspondence Between Pushbuttons and Relay Output
- III. PC Software Installation and Operation Guide
- IV. Additional Applications
- V. General Specification



Chapter 1 Warranty

1 - 1 Warranty

Gain Electronic Co., Ltd. guarantees that this equipment meets its published it should work as expected. However, GAIN does not guarantee that operation in SAGA1 system is error free or without intermission.

1 - 2 Warranty Period

This equipment is warranted against defects in material and manufacturing for a period of one year from the date of shipment. During the warranty period, GAIN is responsible for necessary repairs as long as the product can be proved to be defective.

For warranty service or repair, this product must be returned to a service facility designated by GAIN. Buyer will pay shipping charges to GAIN, while GAIN will pay return shipping charges.

1 - 3 Excluded Items

This warranty does not include consumptive parts such as batteries, fuses, buttons, and relays. Also this warranty does not cover defects caused by improper installation, improper or insufficient maintenance, unauthorized modification, improper operation, ignorance of environmental specifications, or improper software or interfacing.

1 - 4 Remarks

1. No other warranty is expressed or implied, except for the above mentioned.
2. The remedies provided herein are the buyers' sole and exclusive remedies. GAIN shall not be liable for any direct, indirect, special, incidental or consequential damages.



Chapter 2 Operating Precautions

2 - 1 Attention

1. Read this manual carefully before operating and installing SAGA1-L10/L12.
2. Due to the complex nature of equipment, it is necessary to read the entire manual before installation.
3. Never allow any unauthorized personnel to dismantle equipment as this may cause the equipment to be damaged.
4. The equipment has been stringently tested for quality before delivery from our plant. However, it must not be used in extremely dangerous situations, or where damage may result.
5. After operating the Crane, switch off main power as well as the power on the Receiver and remove the Transmitter key.
6. The Transmitter should be safely placed when not in use to avoid accidental pressing of buttons.
7. The Crane should be equipped with a main power Relay, Limit Switch and other required safety devices.
8. Don't use this device during electrical storm or where there are conditions of high electrical interference.
9. Ensure that the Transmitter batteries are in good condition and the power for Receiver is normal.
10. Installation and maintenance should be done only while the Crane's main power is off and the Receiver's power is off to prevent electrical shock.
11. The contents of the manual may be amended by the manufacturer without notice.
12. The manufacturer may introduce new functions to the equipment as is necessary; therefore, the descriptions may be subject to change.

2 - 2 Precautions

1. After operating SAGA1-L10/L12, please press EMS mushroom and shut off the main power supply on the Crane & the Receiver and remove the Transmitter key.
2. Stop operating when slow-response occurs due to insufficient Transmitter power, beyond the remote control range or severe interference.
3. Remove the batteries when the equipment is not going to be in use for a long period of time.



4. SAGA is suitable for use in diverse industrial environments correct operating and maintenance will extend the SAGA1 system's life.
5. Check EMS mushroom and the other security functions of the SAGA1 system before daily operation.
6. Presses EMS mushroom when malfunctions or abnormal conditions occur.
7. The operator must be familiar with the following Emergency Procedures before operating.

2 - 3 Emergency Procedures

In case of emergency, please follow the steps below:

1. Press EMS mushroom.
2. Turn the security key or rotary key switch to "OFF" position.
3. Remove the battery box and key.
4. Shut off the main power of the Crane and discontinue the operation.
5. Contact the distributor to find out reasons.

Chapter 3 Standard Accessories

A standard and full set of SAGA1-L10/L12 is consist of:

SAGA1-L10

Transmitter (strap included) - 1 unit



Receiver - 1 unit

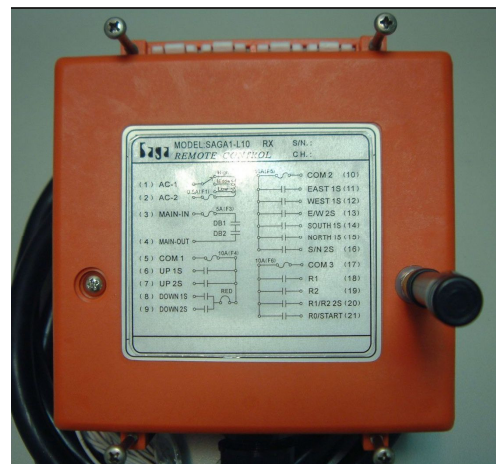

SAGA1-L12

Transmitter (strap included) - 1 unit



Receiver - 1 unit



Chapter 4 Operation

4 – 1 Transmitter Configuration

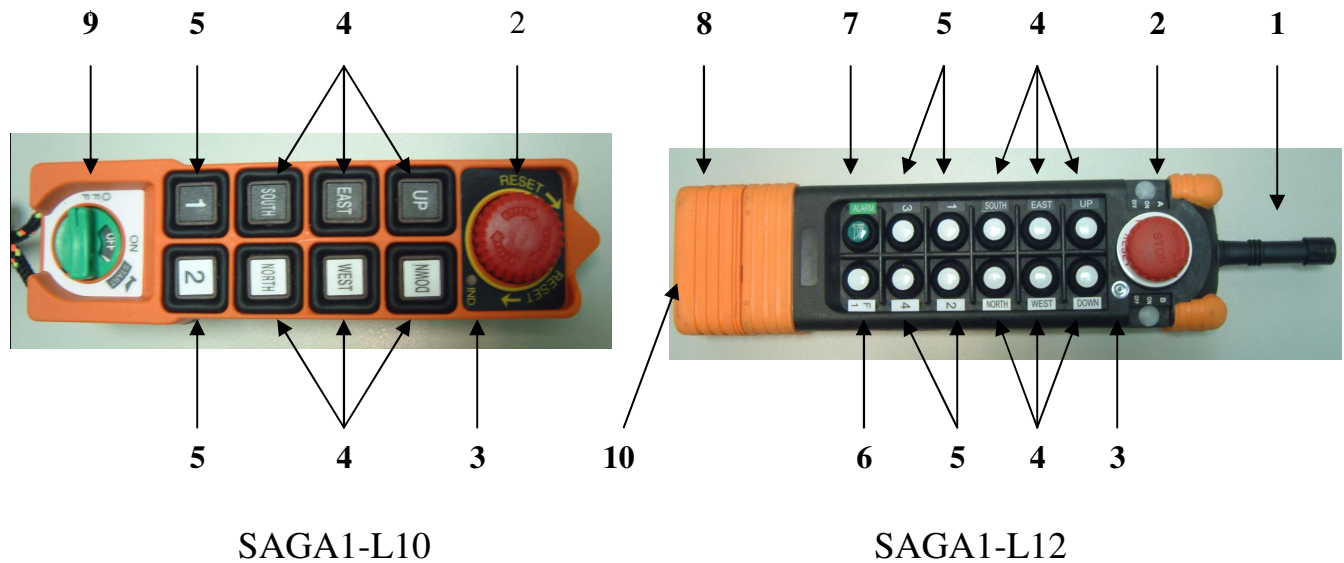

Figure 4-1 Transmitter Configuration

- | | |
|----------------------------|----------------------|
| 1- Antenna | 6- F1 Pushbutton |
| 2- Emergency Stop | 7- Start Pushbutton |
| 3- LED Indicator | 8- Battery Cover |
| 4- Motion Pushbutton | 9- Rotary Key Switch |
| 5- Aux. Pushbutton R1 ~ R4 | 10- Security Key |



4 – 2 General Operation

1. Install 2 new AA-size alkaline batteries in the battery box of SAGA1-L12, then insert into battery case of transmitter; or battery chamber of SAGA1-L10, and screw up transmitter's bottom cover. Make sure the "+" and "-" directions are correct. .
2. Insert security key in the "OFF" position.
3. Turn on the power according to the "Power-On Modes".
Note: LED indicator will flash with red color if proper procedures are not followed.
4. Operate transmitter by pressing each pushbutton.
5. After operation, perform the following procedures in sequence: (1) Press EMS mushroom, (2) rotate security key or rotary key switch counterclockwise to the "OFF" position, (3) remove key and keep it in a safe place, (4) remove batteries if not to be used for a long period of time.

4 – 3 Special Functions Operation

4-3-1 Power-On operations

Power-on means that the Main-Relay on the receiver will switch on as soon as the transmitter sends a signal and then the receiver will be on standby for continuous control. There are 2 options for "Power-On Mode":

A. Any pushbutton Power-On Mode

1. Rotate "EMS" mushroom clockwise 45° and pull out.
2. Turn security key clockwise to "ON" position for SAGA1-L12; Rotary key switch clockwise to "ON" position for SAGA1-L10.
3. Press any pushbutton on the transmitter. This will turn on the power as well as execute the function of pushbutton.

B. "Start" pushbutton Power-On Mode

1. Rotate "EMS" mushroom clockwise 45° and pull out.
2. Turn security key clockwise to "ON" position for SAGA1-L12; Rotary key switch clockwise to "ON" position for SAGA1-L10.
3. Press "Start" pushbutton on the transmitter to turn on power for SAGA1-L12; Continue to turn rotary key switch to "START" position to turn on power for SAGA1-L10(the rotary key switch will return to "ON" position

automatically after been released).

4-3-2 Acceleration Operation

1. For SAGA1-L12 : “Start” pushbutton is the acceleration pushbutton.
2. For SAGA1-L10 : “Start” key is the acceleration key to use.
3. When a motion is in the second speed, quick touch of acceleration pushbutton will accelerate the speed. Repeated touch of acceleration pushbutton will increase the speed.

Note: When accelerating, the motion pushbutton must be depressed and held in the second speed. If motion pushbutton is released, there will be no acceleration and speed will return to zero.

4-3-3 Inching Operation

1. “Start” pushbutton(or key) is set for “inching” function.
2. Press or turn and hold inching pushbutton or key.
3. Press any motion pushbutton to perform the inching motion.

Note: The other pushbutton of transmitter must be released before press inching pushbutton.

4 – 4 The Use of Copier

1. Insert the six pins female plug of copier into the male socket inside the TX or RX of SAGA1-L10/L12.
2. For copying and saving the data from TX or RX, put on the magnetic key onto the receptor to connect; for transferring the saved data from copier to TX or RX, release the magnetic key from the receptor.
3. Press and release “1” pushbutton (or 2, 3) to copy and save the data (When magnetic key is on) from TX or RX, after the green indicator light has flashed, the transfer is finished, disconnect the plug. Proceed the same procedure to transfer the data from copier to TX or RX. (When magnetic key is off)

Note: 1.Make sure the power of TX or RX is off when copying.

2.The copier for SAGA1-L10/L12 (dual colors on the appearance) can also be used for existing SAGA1-L4/6/8/6B/8B, the old one (blue) can not be used for SAGA1-L10/L12.

3.The copier can copy both function settings and ID-Code, but to pair the crystal is still essential to match both TX and RX for communicating each other.

4 – 5 Change of Frequency

It is easy to change frequency of the SAGA1-L series simply by replacing correspondent frequency crystal in both the TX and RX.

***Note:** To replace a new crystal, please note that there are two kinds of frequencies (VHF and UHF) available. The indication of VHF or UHF is shown on PC board with a check mark “V” and please make sure not to replace a VHF crystal unit into UHF PC board or vice versa.*

Instructions:

- (1). Pry up the crystal unit with a flat screwdriver.
- (2). Remove the crystal unit from the system.
- (3). Use a needle nose pliers to straighten both pins of the new crystal unit.
- (4). Insert the new crystal unit vertically into the PC board.
- (5). Press the new crystal down into the socket.

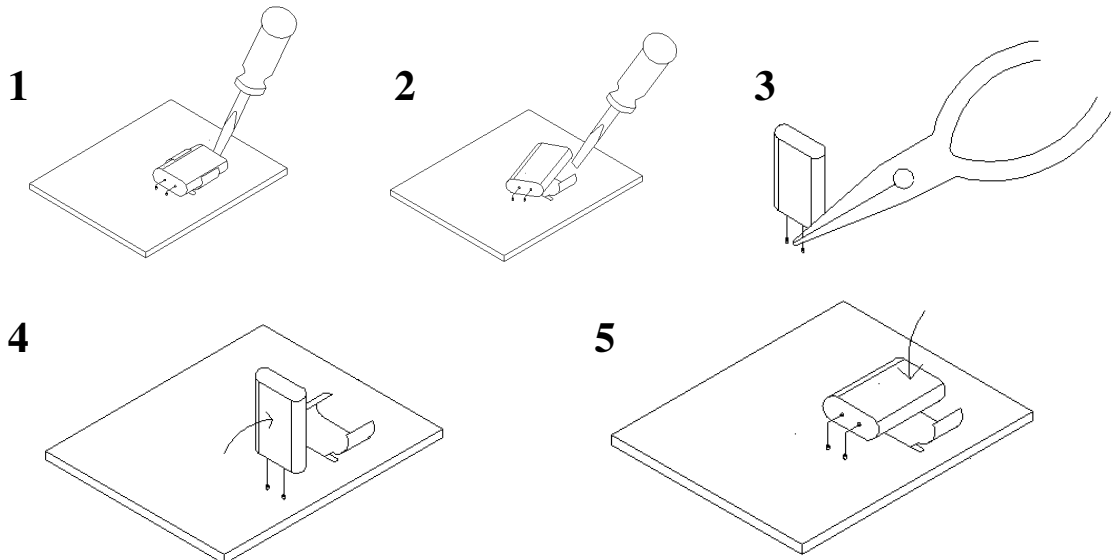

4 – 6 ID-Code Remote Setting

ID-Code remote setting allows you to pair the new TX or RX if one of them is damaged. Using ID-Code remote setting will make both the TX and RX to have the same ID-Code.

1). Please make sure the following conditions before ID-Code remote setting:

- (a) Both TX and RX are of the SAME model and frequency.
- (b) Place the transmitter as close as possible to the receiver to avoid interference.
- (c) Turn off the RX power more than 10 seconds and turn it on again.

2). ID-Code remote setting Instructions:

- (a) Press and hold the transmitter EMS button.
- (b) Press UP pushbutton and hold it.
- (c) Press DOWN pushbutton 4 times and release “EMS & UP” pushbuttons when the red light on the transmitter is flashing.
- (d) Start the system as usual.

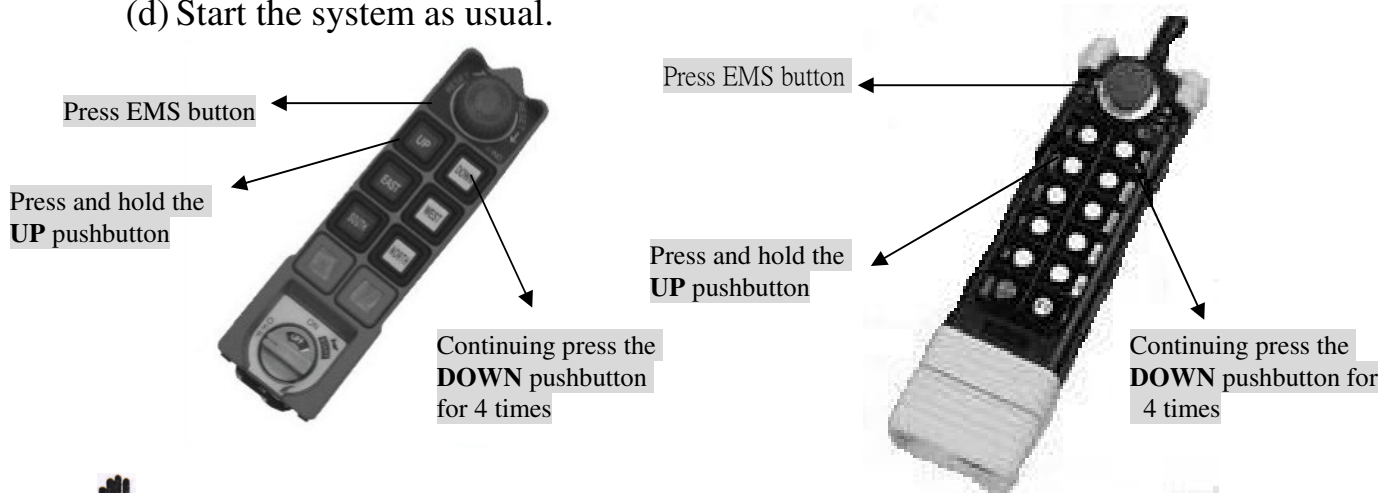

ATTENTION:

- * In case ID-Code remote setting fails, repeat the instructions above within 4 minutes.
- * ID-Code remote setting is available for ID Code only. It will not change function settings.
- * Within the operating distance, all same model systems on the same frequency will be paired with the transmitters ID Code.
- * A jumper added inside the receiver is necessary to enable the ID-Code remote setting function.

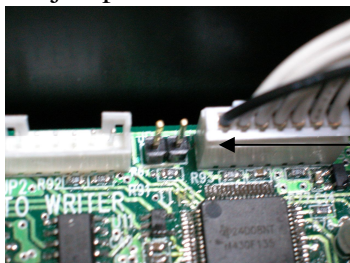

L10 RX

Jumper to add
for ID-Code
remote setting

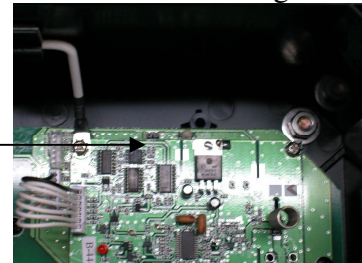

L12 RX

4 – 7 Receiver Voltage Selection

There are two types of power voltages (DC and AC) available for the SAGA1-L series:

(1) DC Type:

Input Voltage : 12~24 VDC

Relay Contact: 10A-36VDC

2) AC Type:

Three different AC transformers: 48/110/220V, 48/220/380V, 110/220/380V.

Please disconnect the RX's power, select the proper voltage and plug in the connector.

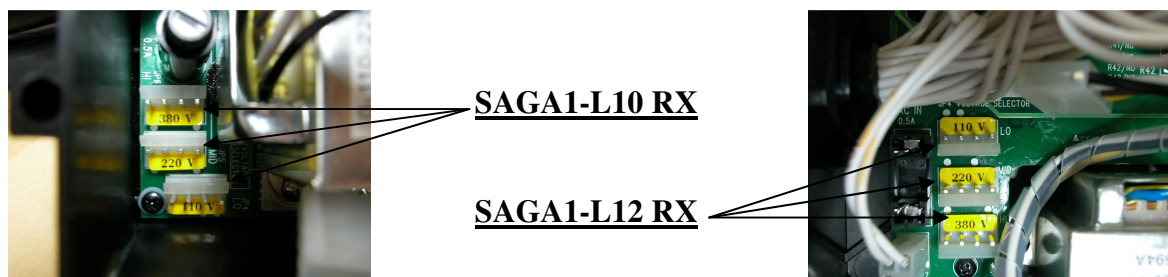

Switch the plug to choose voltage

4 – 8 Transmitter Battery Adoption

Two AA size alkaline batteries are required for the transmitter. The LED will flash green when the battery power is sufficient. The LED will flash red when the battery power is low.

* The operating distance will become shorter and intermittent when the battery is low.

* Replace with new battery when battery power is low.



Do not use rechargeable batteries.

APPENDIX I Function Setting (Defined by Customer)

1. Pushbutton Function setting:

1-1. "UP/DOWN", "EAST/WEST", "SOUTH/NORTH", "R1/R2", "R3/R4"

Pushbutton Function Setting:

Item	Title	Content	Description
1	Button Function	1.Normal/Normal 2.Toggle/Toggle 3.No/Off 4.Normal/Toggle 5.Dual Motors(1)/ Dual Motors(1) 6.Dual Motors(2)/ Dual Motors(2) 7. 3 Speed Acce./ 3 Speed Acce. 8.Digital Acce./ Digital Acce. 9.Normal/Dual Motors(1) 10.Normal/DualMotors(2) 11.Toggle/Dual Motors(1) 12.Toggle/Dual Motors(2) 13.Toggle/3 Speed Acce. 13. Synthesis/Synthesis NOTE: SAGA1-L10 only Up/Down pushbuttons are for full functions, the rest are with <u>Normal</u> , <u>Toggle</u> , <u>On</u> , <u>Off</u> only.	<p>Normal: The relative relay is "on" when the pushbutton is pressed and held, on the other hand the relative relay is "off" when the pushbutton is released.</p> <p>Toggle: To press the pushbutton and release once for "on", re-press and release for "off" cyclically is called "Toggle".</p> <p>ON & OFF: Two relative pushbuttons are set to respectively control the same relay. If a pushbutton set as "on" is pressed and released, thus the relay remains conductive. At this time, the other pushbutton can't change the situation of this relay except the pushbutton set as "off".</p> <p>Dual Motors(1): When pushbutton is released from 2nd speed and back to 1st one, the 1st speed relay is activated again till the pushbutton is totally released.</p> <p>Dual Motors(2): When pushbutton is released from 2nd speed and back to 1st one, the 1st speed relay is not activated but bypassed to nothing.</p> <p>3 Speed Acce.: Use "Start" to accelerate to 3 speed.</p> <p>Digital Acce.: Use "Start" to accelerate to 4 speed.</p> <p>Synthesis: Three relays used for two dual speed motions, the fourth relay work as independent "toggle" on and off function when two pushbuttons pressed simultaneously and again.</p>
2	Acce. Delay	0~4.0 sec.	This function is used to set the time interval between acceleration relays (i.e. conduction delayed time of acceleration relay). It is suitable for accelerative operation to prevent the crane from running to a higher speed to damage the motor.

3	EMS Control	1. Ctrl. by EMS 2. Bypass EMS	<p>Control by EMS: means the corresponding relay of function pushbutton is controlled by EMS mushroom or emergency stop signal.</p> <p>Bypass EMS: means the corresponding relay of function pushbutton will not be controlled by EMS mushroom or emergency stop signal.</p>
4	Interlock Function	1. Interlock delay 0~2 sec. 2. Non-Interlocked	<p>Interlock: If it is dangerous or improper to operate two motions at the same time, select “Interlock”. Delay time means the time interval before next motion is valid.</p> <p>Non-Interlocked: If two motions are safe or irrelevant to operate at the same time, select “Non-Interlocked”.</p>

1-2. “START/F1” Pushbutton Function Setting:

Item	Title	Content		Description
1	Button Function	START	F1	<p>Inching: “Inching” means once the pushbutton is pressed, relative relay will be activated within some certain period of time to operate a short but precise movement. Press and hold inching pushbutton and then press motion pushbutton to perform the inching motion.</p> <p>Acceleration: When the motion is at the 2nd speed, quick pushing on acceleration pushbutton will accumulate one speed each time and the relative relay will turn on accordingly. When accelerating, the motion pushbutton must be pressed and held in the 2nd speed. If motion pushbutton is released, there will be no acceleration and the speed will return to zero.</p>
		1. Normal 2. Toggle 3. Inching/ Acce.	1. Normal 2. Toggle 3. Dual Motor(1) 4. Dual Motor(2)	
2	EMS Control	1. Ctrl. by EMS 2. Bypass EMS		<p>Control by EMS: means the corresponding relay of function pushbutton is controlled by EMS mushroom or emergency stop signal.</p> <p>Bypass EMS: means the corresponding relay of function pushbutton will not be controlled by EMS mushroom or emergency stop signal.</p>
3	Inching	0.1~4.0 sec.		Select the time interval of each inching motion.
4	Acceleration Delay	0~4.0 sec.		Select the time interval for each acceleration.

2. Transmitter Function Setting:

Item	Title	Content	Description
1	Power-On Mode	1. Any Pushbutton 2. Start Pushbutton	<p><u>Any Pushbutton:</u> When mushroom is released and security or rotary key is at “on” position, the receiver will be “Power-On” by pressing any pushbutton on transmitter.</p> <p><u>Start Pushbutton:</u> When mushroom is released and security or rotary key is at “on” position, the receiver will be “Power-On” only by pressing “Start” pushbutton on transmitter.</p>
2	Transmit Mode	1. Non-Continuous 2. Continuous 15 sec.~30 mins off. 3. Continuous Never off	<p><u>Non-Continuous:</u> Once the receiver is “Power-On”, the transmitter will transmit signal only when pushbutton is pressed. This mode can save the power of transmitter.</p> <p><u>Continuous due time off:</u> Transmitter will transmit signal continuously during “Power-On”, and stop sending if no pushbutton pressed within selected time.</p> <p><u>Continuous Never off:</u> Transmitter will keep sending signal unless turned off manually.</p>
3	Auto Off	1. Enable 2. Disable	<p><u>Enable:</u> When Transmit Mode is for continuous, it will send an EMS signal to “Power-off” the receiver if it is set auto off in a certain time.</p> <p><u>Disable:</u> Disable the function to send EMS signal to receiver before the transmitter is off.</p>
4	Normal OP LED	1. On 2. On Every 1~4 sec. 3. Off	<p><u>On:</u> LED indicator will lighten with green color when transmitter is transmitting. It still works for warning and fault indication with first priority.</p> <p><u>On Every 1~4 sec.:</u> LED indicator is flashing with green color every 1~4 sec.</p> <p><u>Off:</u> LED indicator will not work during normal operation in order to save power. But it is still available for warning and fault indication.</p>
5	Powersaving	1. Enable 2. Disable	<p><u>Enable:</u> By using firmware to control frequency transmission cycle period, thus to reduce power consumption of transmitter. Simultaneously, the operating distance will be decreased when the “Powersaving” mode is enabled.</p> <p><u>Disable:</u> Disable this function.</p>



6	Remote Setting	1. Enable 2. Disable	<p>Enable: Allow the transmitter to do ID-Code remote setting.</p> <p>Disable: Not allow ID-Code remote setting on transmitter.</p>
---	----------------	-------------------------	---------------------------------------------------------------------------------------------------------------------------------------------------















3. Receiver Function Setting:

Item	Title	Content	Description
1	Passive Act	1. Relay-off 2. Power-off	<p>Passive Act: The function of this item is used to set the reaction of receiver when no command signal received from transmitter in certain time (the default time is 0.5 second).</p> <p>Relay Off: means the Main Relay is still “on” but the other relays with the function of “Normal” are all de-energized. It is not necessary to recommence the procedure of “Power-On” again to continue operating.</p> <p>Power-Off: means the Main Relay and all of the other relays with the function of “Normal” and “Control by EMS” are going to de-energize and it is essential to recommence the procedures of “Power-On” again to continue operating.</p>
2	Passive Act Timing	0.1~4.0 sec	The duration working time of receiver between passive act is activated and the power or relay is really off.
3	Auto-off (RX)	1. None-execute 2. 10 mins ~ 4 hrs Power-off	<p>None-execute: The main relay of receiver will remain energized unless was Power-off manually</p> <p>10 mins ~ 4 hrs Power-off: If receiver doesn't receive the correct control data within a certain time, then the main relay on receiver will be de-energized automatically (i.e. receiver Power-off). Normally this function is used with “non-continuous transmitting mode” in case operator forgot to turn off the transmitter.</p>
4	Remote Setting	1. Enable 2. Disable	<p>Enable: Allow the receiver to do ID-Code remote setting.</p> <p>Disable: Not allow ID-Code remote setting on receiver.</p>

APPENDIX II Correspondence Between Pushbutton and Relay Output

All SAGA1-L12 is equipped with 4 relays in each group of motions, such as Up/Down, East/West, South/North, R1/R2, R3/R4; however SAGA1-L10 only Up/Down is with 4 relays, others with 3. Their corresponding relation is shown as below:

 Means relay is on
  Means relay is off

UP		Down	
1.Normal/Normal			
1 st Step	2 nd Step	1 st Step	2 nd Step
			
2.Toggle/Toggle			
1 st Step		1 st Step	
			
3.On/Off			
1 st Step		1 st Step	
			
4.Normal/Toggle			
1 st Step	2 nd Step	1 st Step	
			
5.Dual Motor(1)/Dual Motor(1)			
1 st Step	2 nd Step	1 st Step	2 nd Step
			

Note: When pushbutton is released from 2nd speed and back to 1st one, the 1st speed relay is activated again till the pushbutton is totally released.

6. Dual Motor(2)/Dual Motor(2)



Note: When pushbutton is released from 2nd speed and back to 1st one, the 1st speed relay is not activated but bypassed to nothing.

7.3 Speed Acce./3 Speed Acce.

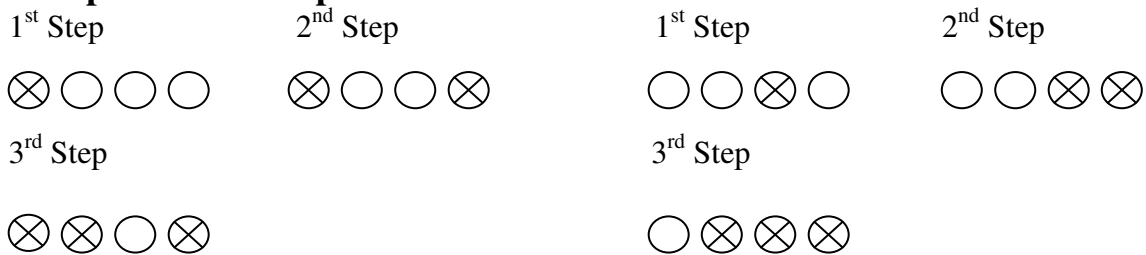

Note: The second step pushbutton must be pressed and held when pushing or turning “Start” pushbutton or key to reach third speed.

8. Digital Acce./Digital Acce.

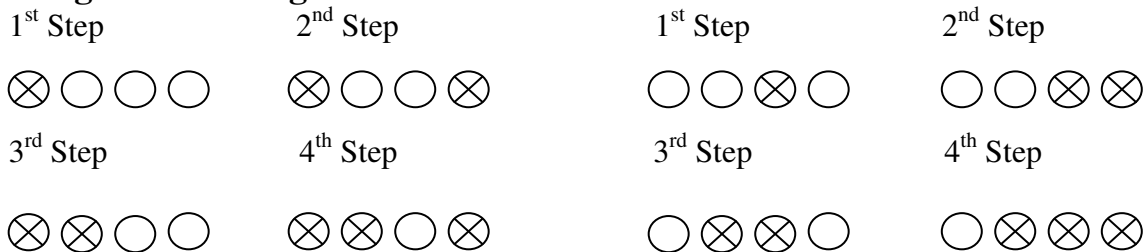

Note: The second step pushbutton must be pressed and held when pushing or turning “Start” pushbutton or key to reach the third and fourth speed.

9. Synthesis/Synthesis

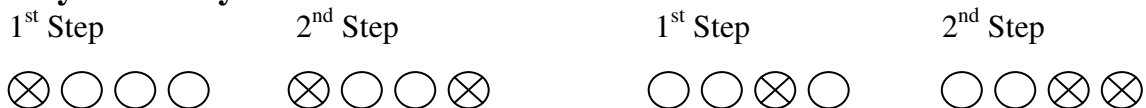

Up + Down



Note: When Up and Down pushbuttons are pressed at the same time the second relay works as “Toggle”, released when they are pressed simultaneously again.

APPENDIX III PC Software Installation and Operation Guide

1. Software Installation:

- 1-1. Open CD-Rom of your computer and insert SAGA1-L10/L12 PC software CD, the program will run automatically. Click “Install” to proceed installing, “Cancel” to exit.

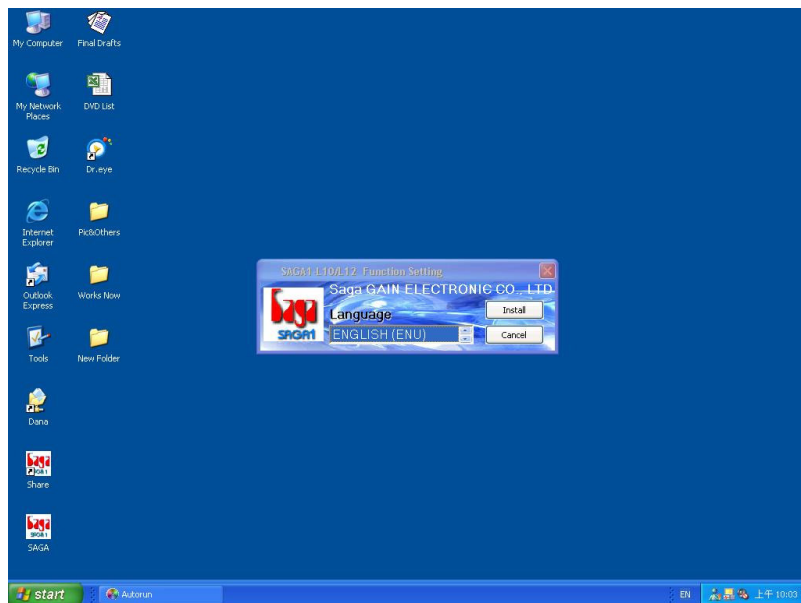

- 1-2. Click “Next” when the screen shows as below.

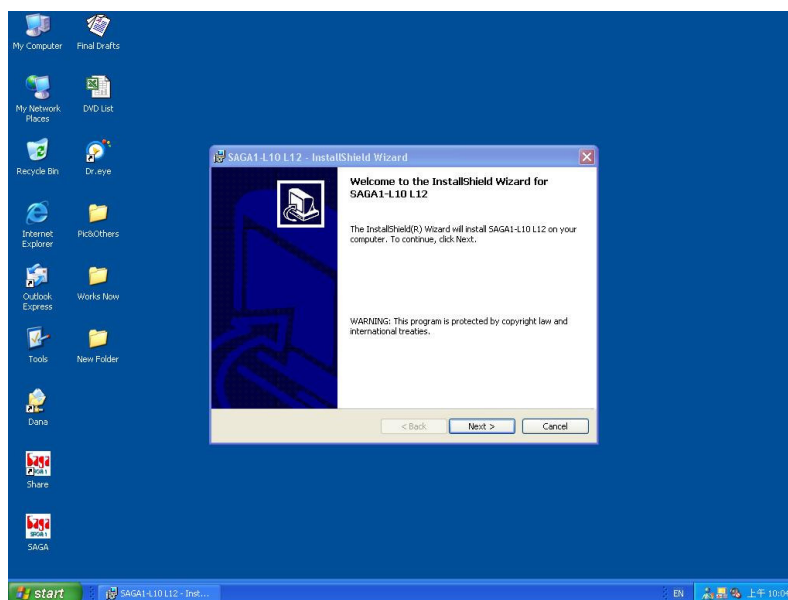



1-3. Click “Finish” to end the installation, then remove the CD from the CD-Rom. The program will add a shortcut on your desktop.

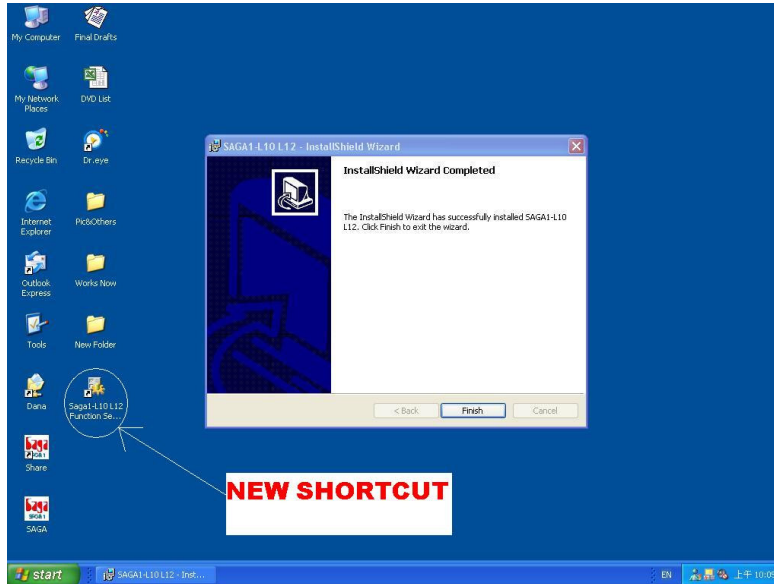

2. Software Operation and Function Setting:

2-1. To activate the program, either double click on the desktop shortcut for SAGA1-L10/L12 software, or from the “start” menu of your Windows:
(start→Programs→SAGA1→SAGA1_L10 L12 Function Setting)

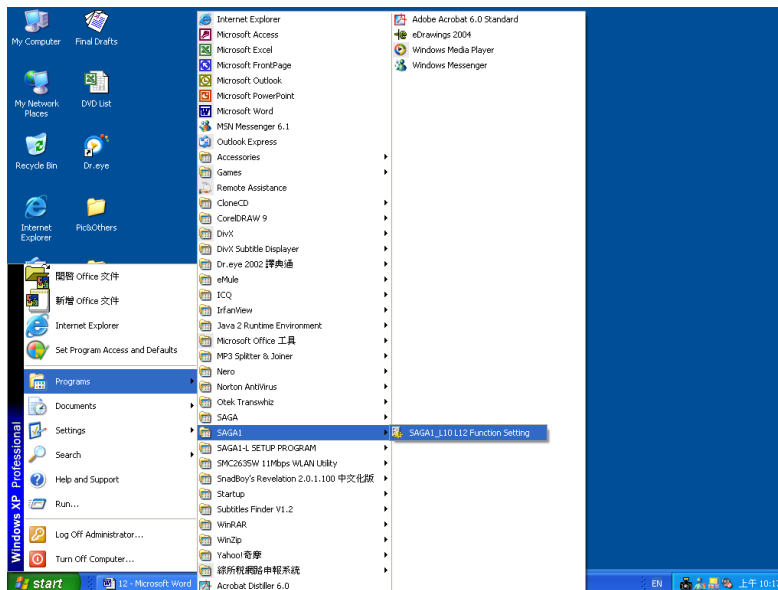

2-2. Default and second page of the program:

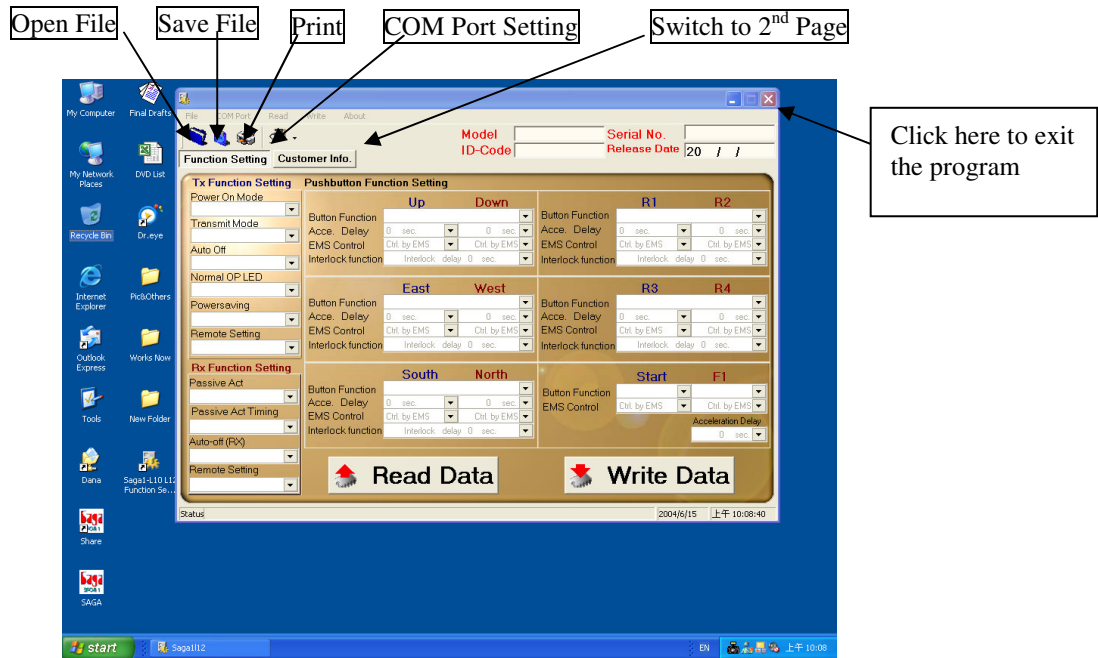

Default Page: Function Setting

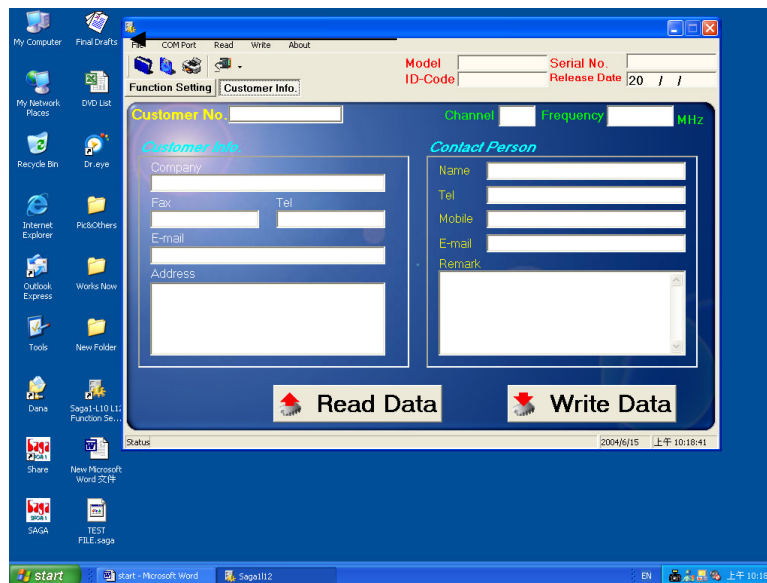

Second Page: Customer Info.



SAGA1-L Series

2-3. Using RS232 connecting cable to connect transmitter or receiver to the computer, click “Read Data” to retrieve the setting, then click “OK” to see the result.

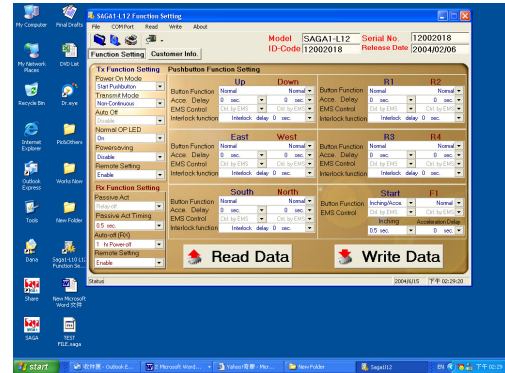
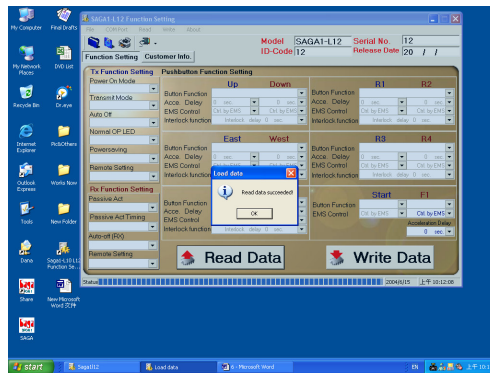

2-4. After changing the function setting (refer to Appendix I & II), either to save the setting data to computer hard disk or write it to another transmitter or receiver. To save the data, click “Save File”, after destination chosen and file name typed, click “Save”. Click “OK”

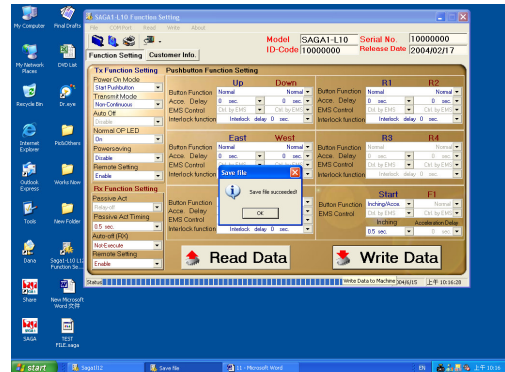
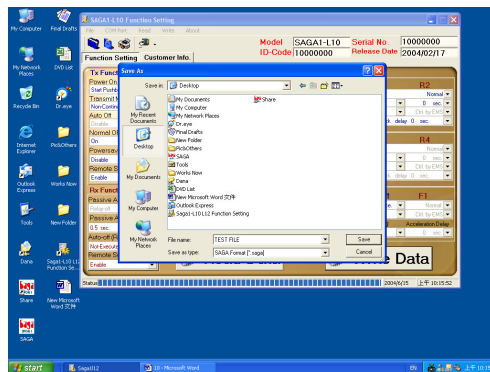

To write to another TX or RX, disconnect the cable from present TX or RX and connect to target TX or RX, click “Write Data”, then click “OK”.

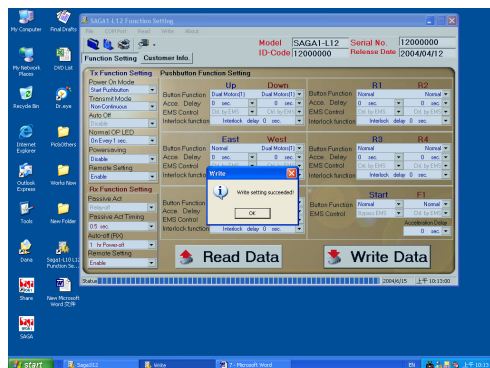



2-5. To read data from saved file, click “Open File”, after the source file (*.saga) chosen, click “Open”, then “OK”.

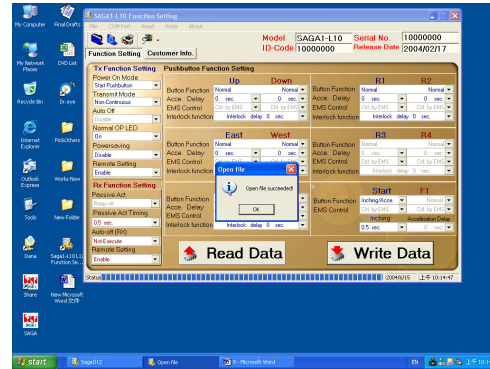
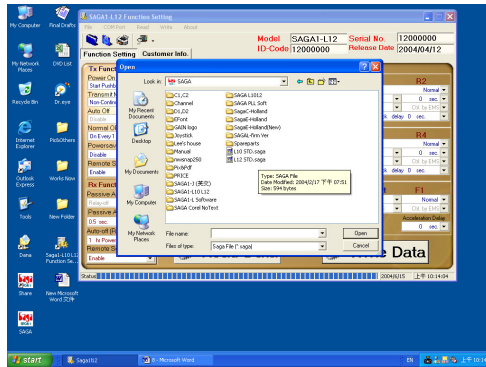

2-6. Second page (Customer Info.) of the program is to store the customers basic information and their setting data, convenient for file sorting and further service, such as to make copy of their lost or malfunction transmitter, also to diagnose their problem from your office.

2-7. To print out the setting or customer info, click “Print”.



APPENDIX IV Additional Applications

1. Exchangeable NC/NO Relays:

There are reserved NC/NO output contacts for an easy exchange of NC or NO relays (The default is NO relay), depending on the customer's need.

For SAGA1-L10, R0/R1/R2 can be changed for either NC or NO relays.

For SAGA1-L12, all relays are allowed being replaced by either NC or NO type.

2. Dispensable COM lines:

Multiple choices to increase more independent COM lines in addition to the existing 3 COM lines, either to fit customer's demands or for safety reason. Connect the new COM via MAIN relay for double indemnity, but go alone when this relay function is meant to bypass EMS. (Extra fuse is necessary when adding new COM)

For SAGA1-L10, one more COM line to use on Down 1S/2S(red wire).

For SAGA1-L12, all relays can be independently isolated as a new COM(blue wires)

3. External Passive Antenna:

Easy to remove the existing antenna or modify the PCB contacts for installing passive antenna when in longer transmission distance, or in severe environment.

For SAGA1-L10, remove the standard Helix antenna and connect the passive antenna to the existing "F" connector.

For SAGA1-L12, remove the standard Helix antenna and weld the "F" connector on the reserved punch holes next to the antenna, then install the passive antenna.



APPENDIX V

General Specification

Frequency Range: 433.05~434.79 MHz

ID Code: 32 Bits

Channel Space: 250 KHz

Hamming Distance: ≥ 4

Housing Material: Reinforced Plastic and Glass Fiber

Protection Class: IP65

Operating Temp.: $-40^{\circ}\text{C} \sim +80^{\circ}\text{C}$

Maximum Operating Range: Up to 100 Meters

TX Emission Power: $< 10 \text{ mW}$